

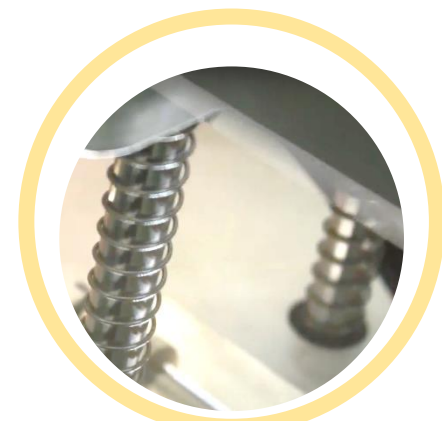

未來的 工作世界



選技職、好好讀、有前途



高職優質化工作小組

簡報 大綱

1

有前途

2

好好讀

3

選技職



1
有前途

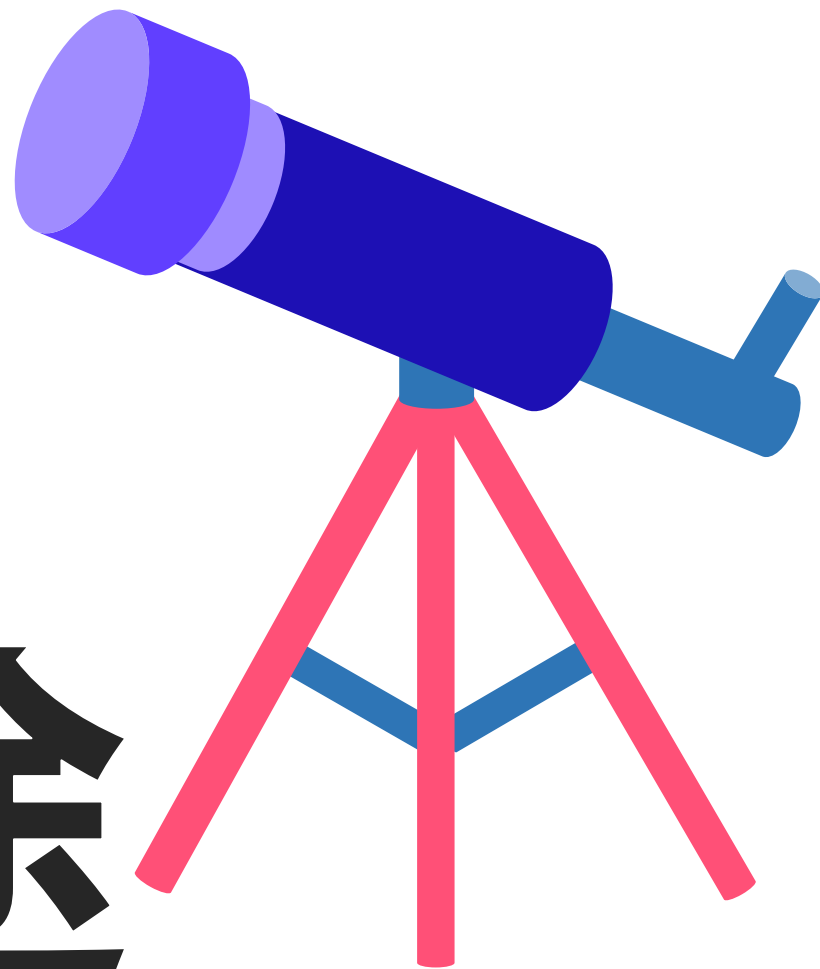



我的生活都離不開技職

日常生活周邊產品（服務）

製造、服務提供者（技術）



以智慧型手機為例



造型、機身結構設計、零組件製造



模具製造或精密機械加工



工業類



造型設計



工業類、
藝術與設計類

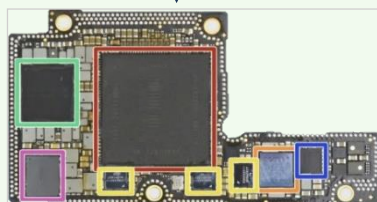

IC設計、電路系統設計與製造



IC設計、電子電路設計



工業類



電路板、零件加工



工業類



網頁設計、資料運用、APP應用程式

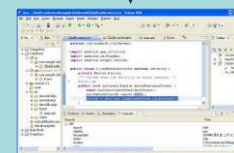

程式設計



工業類、商業類



網頁設計



商業類、
藝術與設計類

以智慧型手機為例



造型、機身結構設計、零組件製造



模具製造或精密機械加工

造型設計



工業類



工業類、
藝術與設計類

以智慧型手機為例

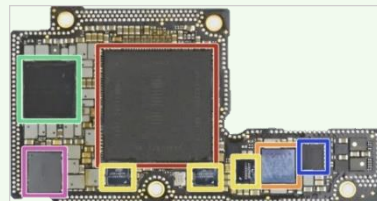

IC設計、電路系統設計與製造



IC設計、電子電路設計



工業類



電路板、零件加工



工業類

以智慧型手機為例



網頁設計、資料運用、APP應用程式

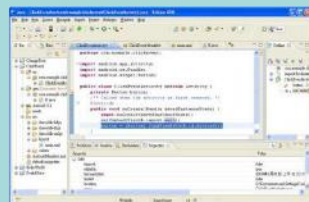

程式設計



工業類、商業類



網頁設計



商業類、
藝術與設計類

以超商飯糰為例



以 超商飯糰 為例



稻米栽培
米食加工



農業類



鮪魚餡料



海事水產類、農業類



食品營養



農業類、家事類



食品加工



農業類

以 超商飯糰 為例



便利商店



商業經營
門市服務



商業類



物流管理



商業類



電子商務



商業類

好好讀

2





技術型高中 6類15群

工業類

商業類

家事類

海事水產類

農業類

藝術與設計類



工業類

動力機械群

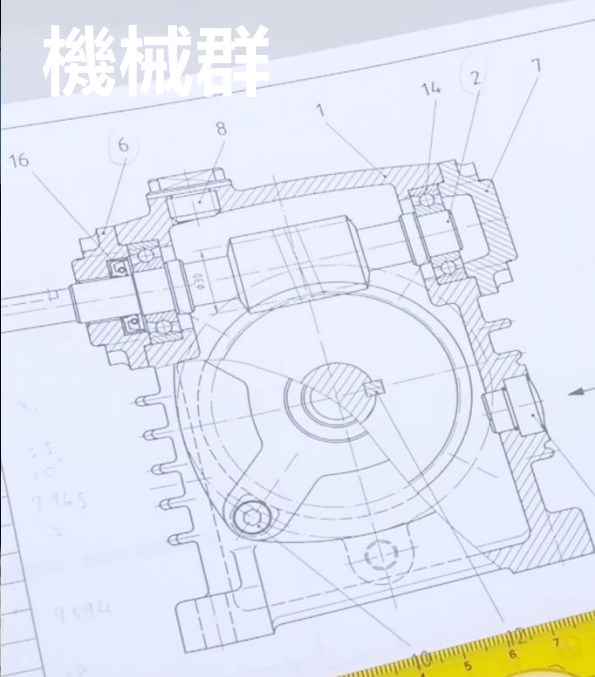

化工群



電機與電子群



土木與建築群



就業選擇

工程師、程式設計師、建築師、專業技術人員等，可從事各種工業生產、製造、生化製藥產業等工作

商業類

Franny and Zooey

J.D. Salinger

Life of Pi



商業與管理群

就業選擇

商業管理、物流管理、商業服務、會計師、金融分析師、國際翻譯人才、經貿等相關行業，或是自行創業（包含實體店面或網路店面）

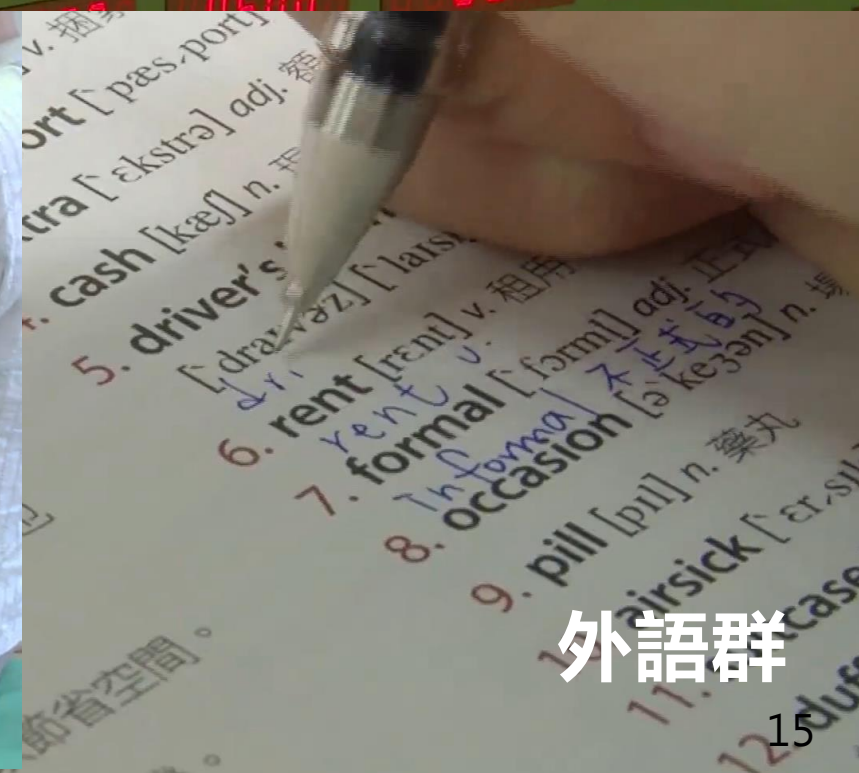

外語群

家事類



餐旅群



家政群

就業選擇

觀光導遊、展場設計、服裝設計、幼兒園教學、社會工作、時尚造型、照顧服務、餐飲服務等相關行業



農業類



農業群



食品群

就業選擇

農牧場經營、園藝造景、植物病蟲害技術人才、獸醫、食品工業、生物技術、食品檢驗分析等相關行業



海事 水產 類

海事群

水產群

就業選擇

國際航海員、引水員、遊艇維修、商船輪機員、休閒漁業導覽、水產養殖相關行業



藝術與設計類



藝術群



就業選擇

動畫設計、視覺藝術、舞台設計、圖文傳播、表演藝術、時尚工藝、舞蹈音樂等相關行業



設計群



技職教育有前途

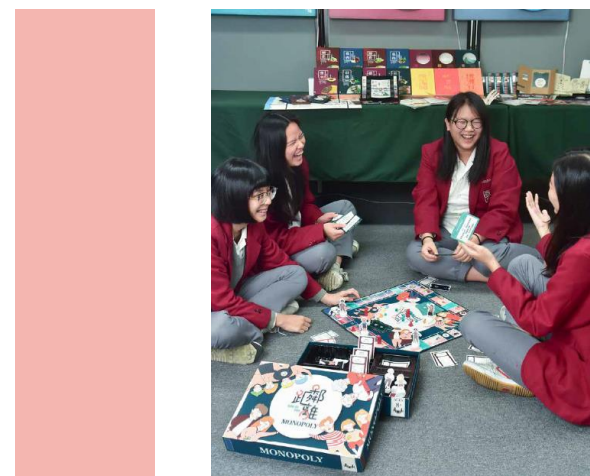

以培育具備專業、
實作技術能力、優
質專業人才為目標

3

選技職



我的未來不是夢

國中畢業生
升學進路圖

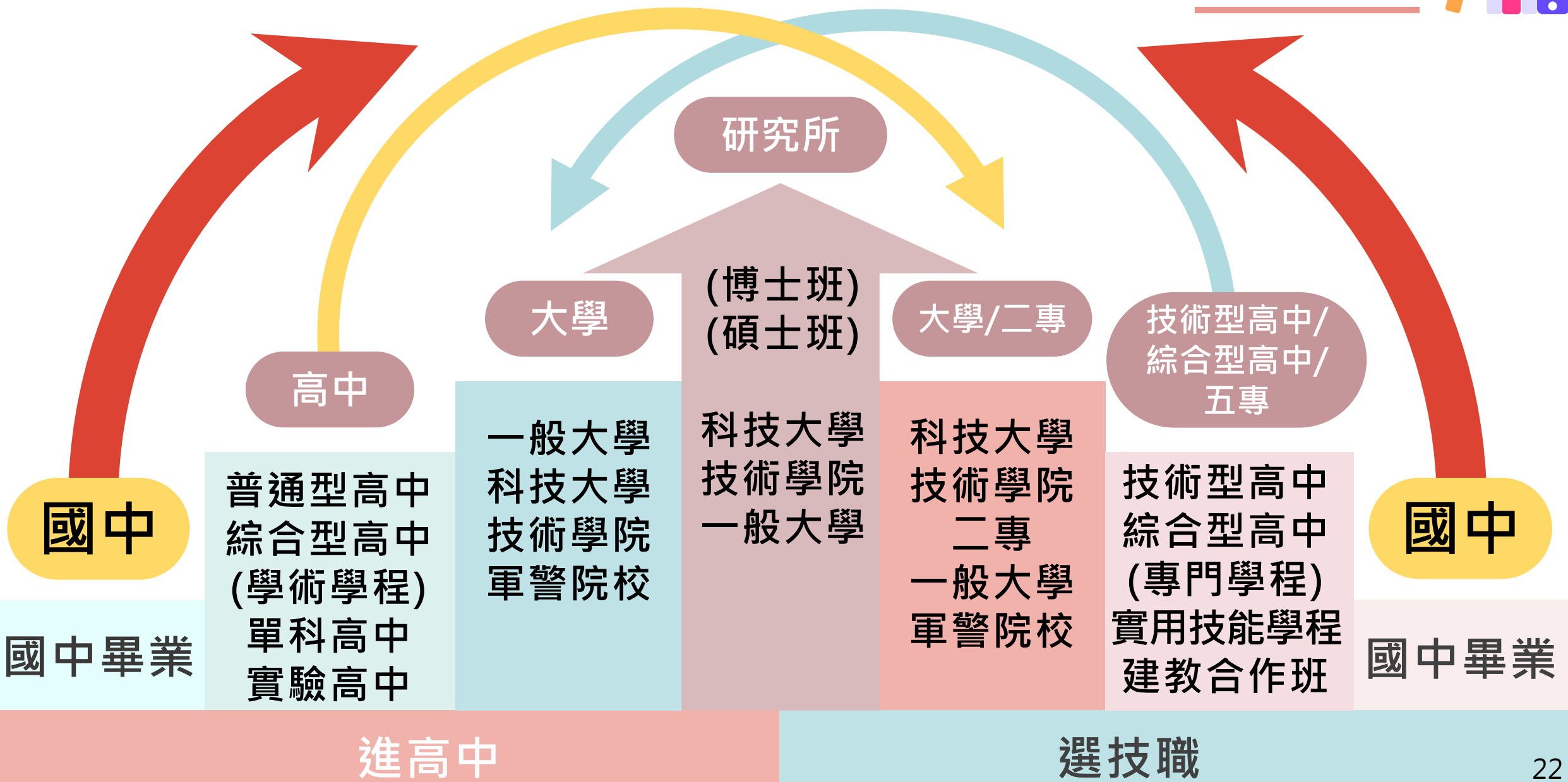

選技職 —築夢踏實

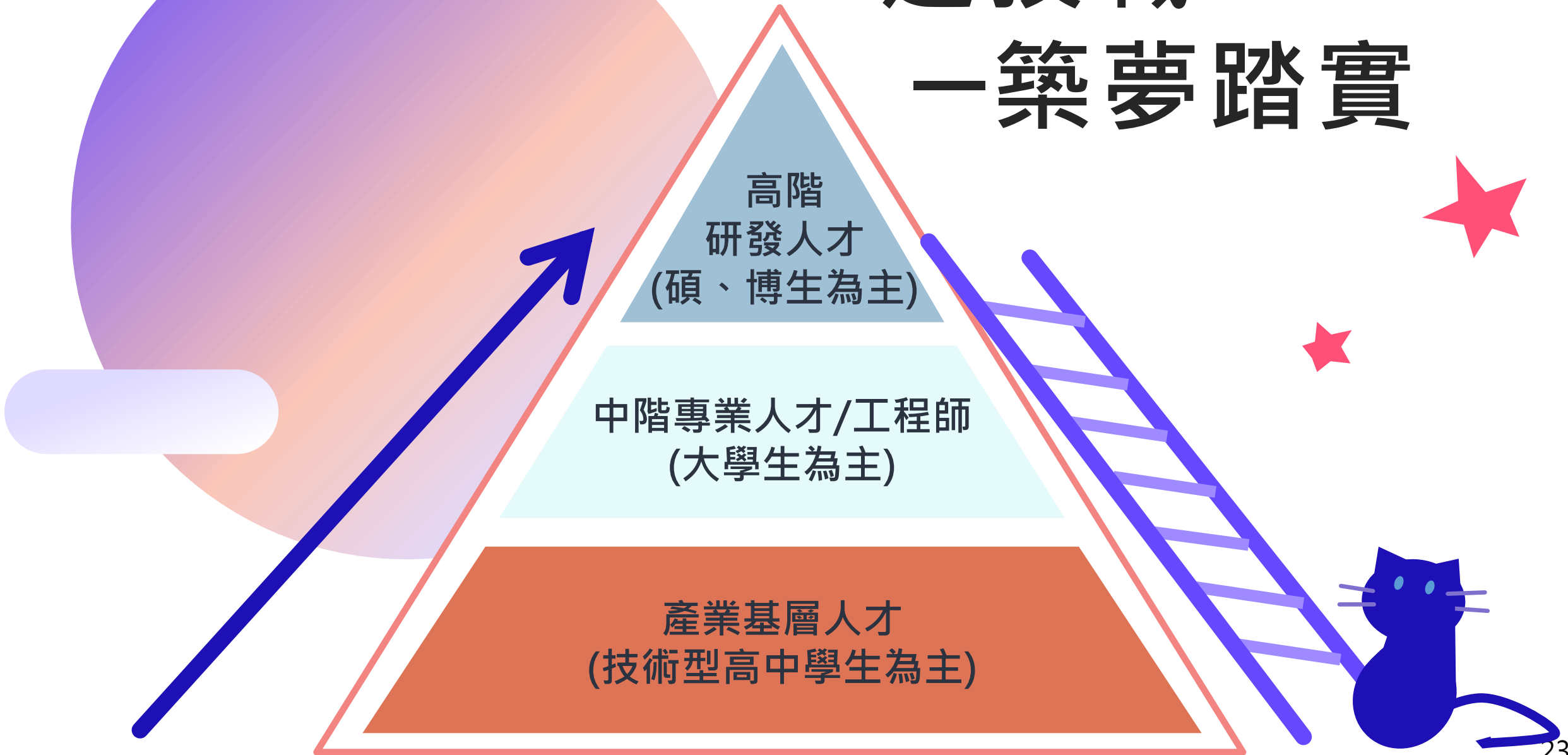

夢想啟航—從認識技職開始

技職大玩JOB 統一公告活動

技職大玩JOB 網站

1. **線上展覽**：360度視角精彩重現上一期展，延續展示效益。
2. **互動體驗遊戲**：輕鬆有趣互動小遊戲，將技職群科知識納入。
3. **梅克獅養成遊戲**：從養成過程中引導完成技職體驗任務。



合作PaGamO 任務書

題型設計有職業、技職群科知識和職業試探展，**限時激勵答題**，提升大眾對技職教育的認識。



技職直播與 採訪報導

1. 邀請**國家產學大師**，以有趣**互動的直播**，即時提問和回覆，幫助學子對於技職教育進一步了解。
2. 採訪**技職之光**和社會上多元職群達人，分享學習與工作經驗。





選技職

好好讀

有前途！